

Ultraliner - Round Liner Range

FW67U - Technical Data Sheet

MILK-RITE®
 animal health and milk quality

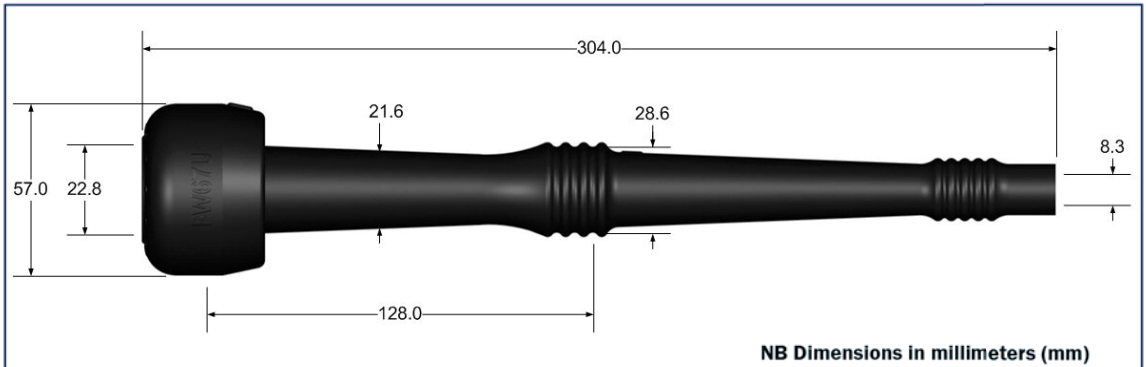

NB Dimensions in millimeters (mm)

Milk-Rite product code	Milk-Rite part number	Compatible with
FW67U	M02FW010AW	OEM: 20167

Material approval



The compound used for this liner meets BfR Food Regulation XXI Category 3 for products that come into contact with food, and is approved to this standard by RAL.

Shell type: Milk-Rite - M10AV015XZ

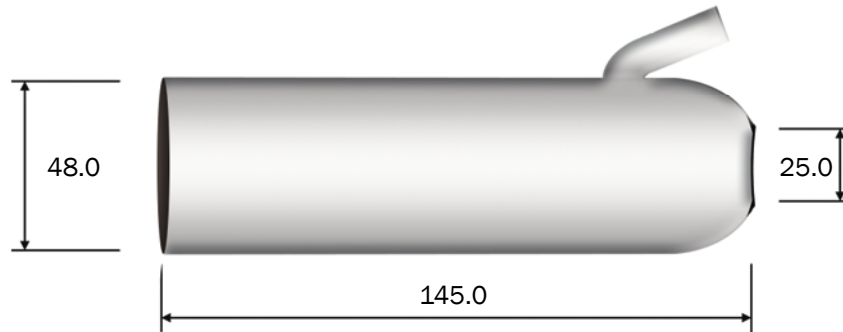

Milk-Rite Warranty

Milk-Rite liners are warrantied to last a minimum of 2500 milkings or six months when used in accordance with our instructions and those of the parlour manufacturer.

The information in this document is not binding and can be changed without notice. Parlours and herds vary considerably, so these details are meant to be guidelines to operation only and not a specification. It remains the responsibility of the operator to ensure the correct working of the plant and the health of the animal.

Milk-Rite, Hampton Park West, Semington Road, Melksham, SN12 6NB

www.milk-rite.com

